

Paladin Medical Products

Architectural Solutions for Clinical Environments

— The Fairfield Legacy Company —



Infection Control. Reduced Operations Costs. Best Practice Clinical Provision.

“EVOLUTION”
EQUIPMENT MANAGEMENT
SYSTEM

EQUIPMENT RAIL
AND
ACCESSORIES
CATALOG

940 W. Oakland Ave, Suite A1, Oakland, FL 34787

(407) 614-8781 office, (407) 614-8782 fax

info@PaladinMP.com

“EVOLUTION”

The Fairfield-Style Medical Equipment Rail



info@PaladinMP.com
(407) 614-8781 office

PART NUMBER: R-XXX

**DESCRIPTION: “EVOLUTION”
Fairfield-Style Equipment
Management Rail**

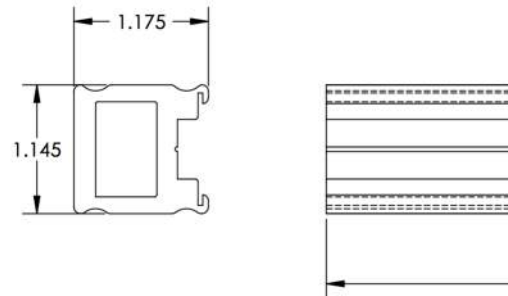

- “EVOLUTION” Equipment Management Rail: a seamless, extruded aluminum profile with clear anodized finish containing a groove for attaching an adapter that supports the Owner supplied specified hospital accessories and equipment and includes termination caps at each end. The groove and adapters are designed so that the adaptor requires a seven degree tilt for attachment. The rail is designed to accommodate a seamless Wilsonart laminate decorative color inlay the length of the rail up to ten feet in length.
- “EVOLUTION” Equipment Management Rail shall be specified in one to ten foot lengths as shown on drawings or indicated on purchase order to accommodate room conditions. For lengths greater than ten feet, a JOINER piece is used to attach together multiple pieces of rail to meet the required total length.
- “EVOLUTION” Equipment Management Rail is pre-drilled on sixteen-inch centers (minimum) with the exception of a one-foot rail length which has two mounting holes drilled at eight inches on center. The Rail may also be field drilled by the installer to accommodate specific job site conditions.
- End caps shall be constructed of injected molded thermoplastic and shall resist most hospital cleaning and disinfecting chemicals. The color shall be white and molded throughout the material. End caps shall be friction-fit without use of fastening devices.
- Decorative inlay shall be supplied by Paladin for installation by the owner or contractor. Inlay is Wilsonart laminate in the standard finish which will resist most hospital cleaning and disinfecting chemicals. Color shall specified by the Owner. Specialty coating finishes can be made available for additional cost and lead time. Alternate laminate manufacturers may be specified for additional cost and lead time. Contact manufacturer for details.



PALADIN “EVOLUTION”

RAIL INSTALLATION OVERVIEW

Rail may be mounted to any surface or backing/wall type.

Installer MUST use a MINIMUM of ¼” mounting hardware.

Contact manufacturer with any installation questions at number shown below.

Refer to the relevant elevation drawings and other specification documentation for quantity and location details for each project.

Stud Mount



1. Position and level the “Evolution” rail on the wall at the correct height and location as shown on the elevation drawings. Mark location on wall.
2. Align holes in rail with studs. If required, drill new holes into rail to align with stud locations.
3. Using a 1/4” x 2.5” sheet metal screw, securely fasten the screws through the rail and drywall and into the studs. Ensure a tight fit between rail and wall.

Drywall Mount

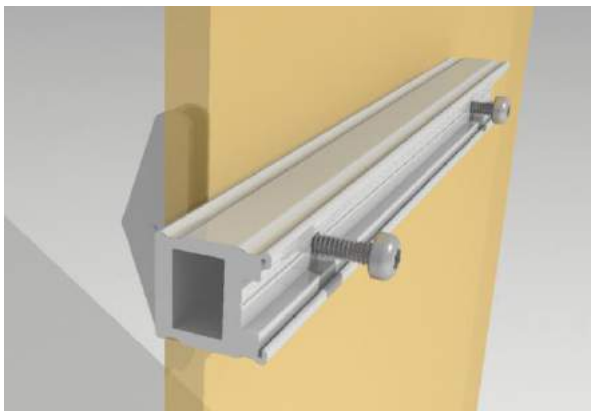

1. Position and level the “Evolution” rail on the wall at the correct height and location as shown on the elevation drawings. Mark location on wall.
2. Mark through each of the pre-drilled holes in the rail onto the drywall.
3. Remove the rail and securely install 1/4” toggle-type wall anchors in locations as marked.
4. Realign the rail holes with the installed wall anchors and tightly secure the rail to the wall with the 1/4” x 2.5” wall anchor machine screws. Ensure a tight fit between rail and wall.

Wall Anchor types A + B



Diagnostic Medical Equipment (DEM prefix part numbers)



PART #	DESCRIPTION
R-205	RAIL, 5'-0"
DEM-109	SPECULA MOUNT
DEM-108	OPHTHALMOSCOPE MOUNT
DEM-110	THERMOMETER MOUNT
DEM-106	BP MANOMETER MOUNT
SM-101	BP CUFF BASKET AND MOUNT

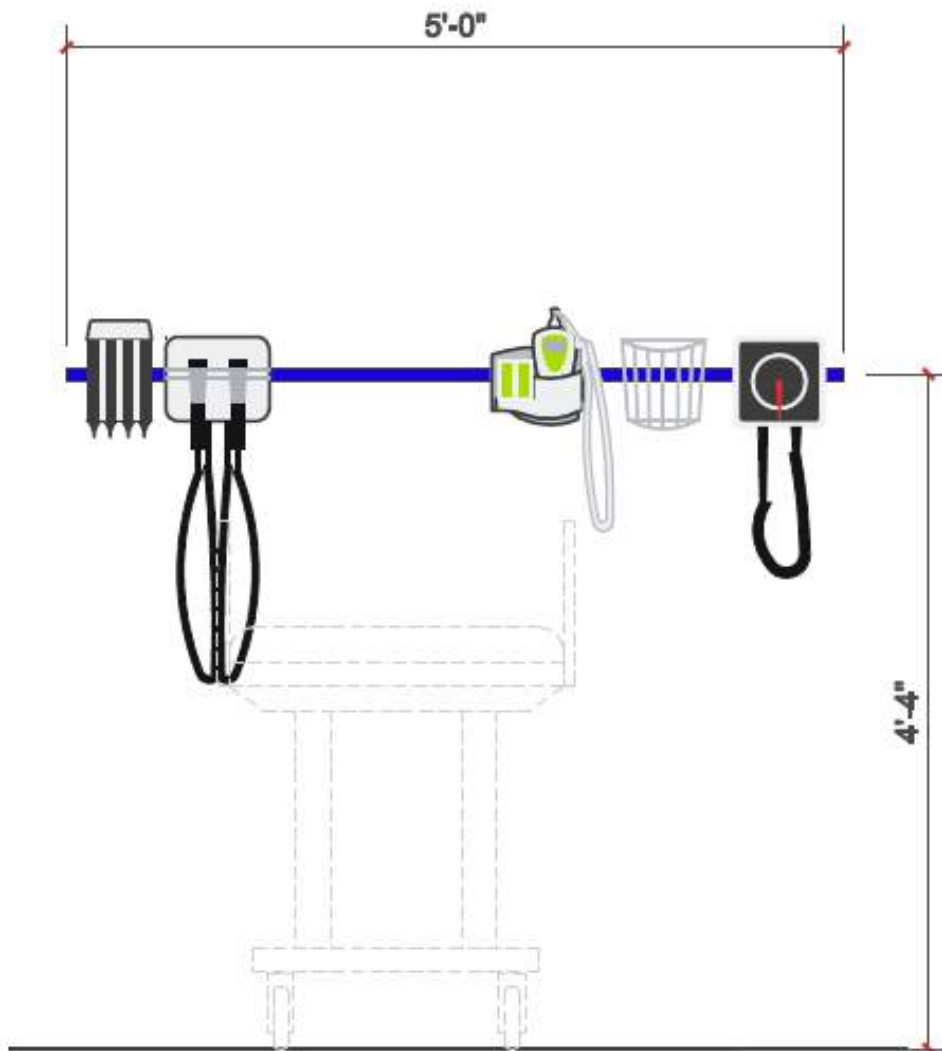

Paladin Medical Products
 Architectural Solutions for Clinical Environments
 The Fairfield Legacy Company

940 W. Oakland Avenue, Suite A1
 Oakland, FL 34787
 (407) 814-8781
 gschindele@paladinmp.com

**TYPICAL ELEVATION
 DIAGNOSTIC EQUIPMENT
 (WELSCH ALLYN)**

SCALE: N.T.S.
 DATE: 05-26-14

TP.DE
 SHEET NO.

COPYRIGHT © 2013 BY PALADIN MEDICAL PRODUCTS. ALL RIGHTS RESERVED. THIS DOCUMENT IS THE PROPERTY OF PALADIN MEDICAL PRODUCTS. IT IS TO BE USED ONLY FOR INFORMATIONAL PURPOSES OR FOR THE SPECIFIC PROJECT IDENTIFIED OR REFERRED TO HEREIN AND IS NOT TO BE USED ON OTHER PROJECTS OR FOR EXTENSIONS TO THIS PROJECT, IN WHOLE OR IN PART, EXCEPT BY EXPRESS WRITTEN AGREEMENT WITH AND COMPENSATION TO PALADIN MEDICAL PRODUCTS.

PACKAGE:
 NOT FOR CONSTRUCTION

PART NUMBER: DEM-106 DESCRIPTION: Mounting Kit, Tycos Aneroid Welch Allyn Model 767

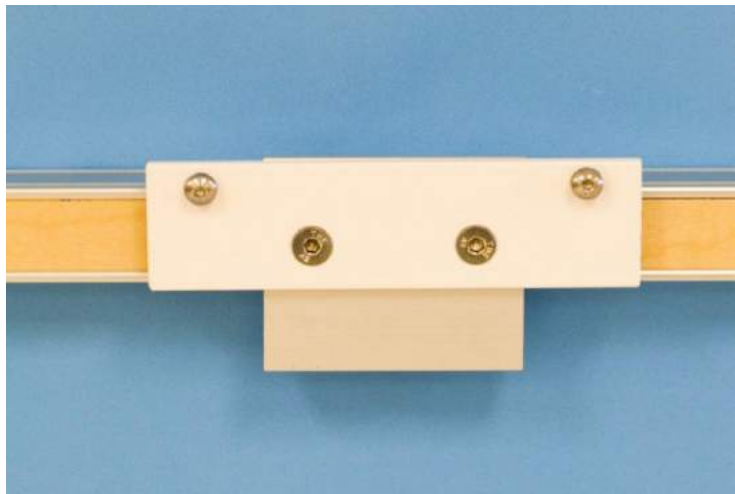

- Designed to hold Welch Allyn Tycos Aneroid Blood Pressure manometer
- Mounts to EVOLUTION, “Fairfield-style” Paladin Medical Equipment Management Rail, using snap action adapter, with positive snap attachment lock feature
- Snap action adapter has tamper proof secured lock feature via allen screws allowing accessory to be tightly locked to equipment rail
- Plate is aluminum with a powder coat anti-microbial painted finish.

940 W. Oakland Ave. Suite A1
Oakland, Florida 34787
Phone: (321) 704-2311
E-Mail: info@PaladinMP.com
Web: www.PaladinMP.com



Paladin Medical Products, LLC
Architectural Solutions for Clinical Environments
— The Fairfield Legacy Company —

PART NUMBER: DEM-108 DESCRIPTION: Holder Welch Allyn Model 767 / 777 Transformer

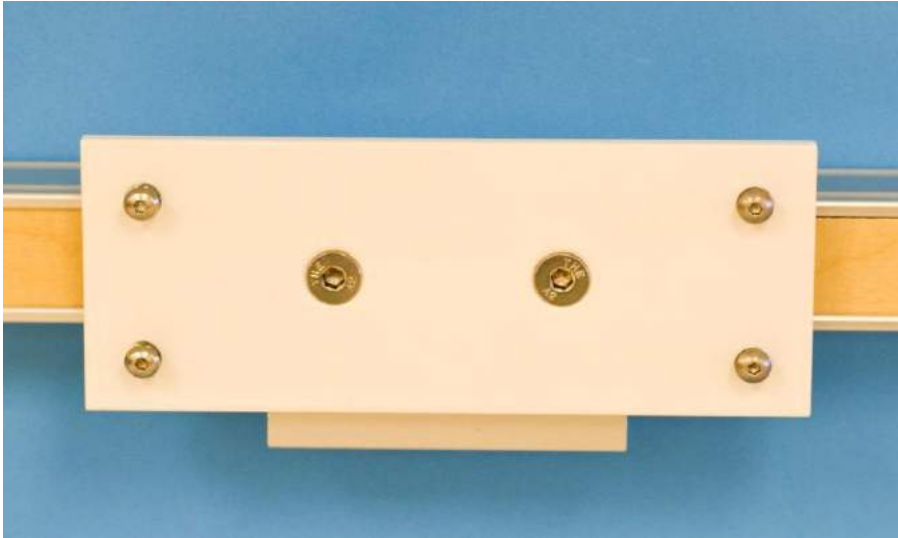

- Designed to hold Welch Allyn 767/777 Ophthalmoscope transformer
- Mounts to EVOLUTION, “Fairfield-style” Paladin Medical Equipment Management Rail, using snap action adapter, with positive snap attachment lock feature
- Snap action adapter has tamper proof secured lock feature via allen screws allowing accessory to be tightly locked to equipment rail
- Plate is aluminum with a powder coat anti-microbial painted finish.

940 W. Oakland Ave. Suite A1
Oakland, Florida 34787
Phone: (321) 704-2311
E-Mail: info@PaladinMP.com
Web: www.PaladinMP.com



Paladin Medical Products, LLC
Architectural Solutions for Clinical Environments
— The Fairfield Legacy Company —

PART NUMBER: **DEM-109**

DESCRIPTION: **Holder Welch Allyn
Speculum Container**

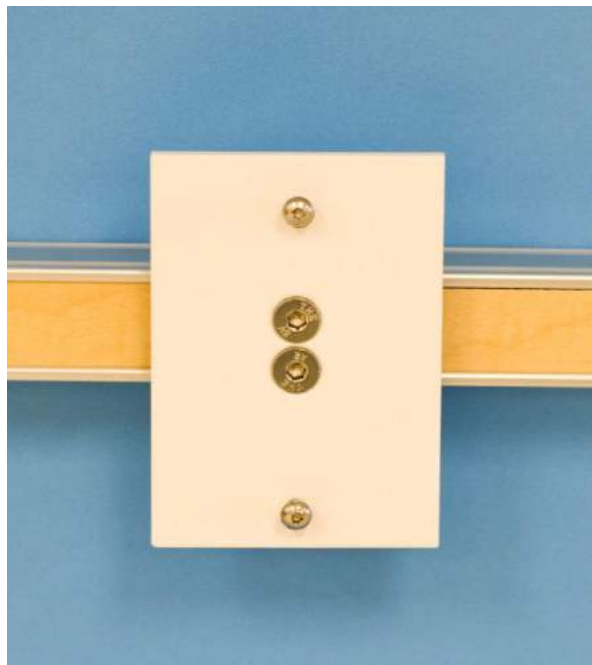

- Designed to hold Welch Allyn Speculum Container holder
- Mounts to EVOLUTION, “Fairfield-style” Paladin Medical Equipment Management Rail, using snap action adapter, with positive snap attachment lock feature
- Snap action adapter has tamper proof secured lock feature via allen screws allowing accessory to be tightly locked to equipment rail
- Plate is aluminum with a powder coat anti-microbial painted finish.

940 W. Oakland Ave. Suite A1
Oakland, Florida 34787
Phone: (321) 704-2311
E-Mail: info@PaladinMP.com
Web: www.PaladinMP.com



Paladin Medical Products, LLC
Architectural Solutions for Clinical Environments
— The Fairfield Legacy Company —

PART NUMBER: **DEM-110**

DESCRIPTION: **Holder Welch Allyn
Model 692 Sure Temp Thermometer**



- Designed to hold Welch Allyn Sure Temp Model 692 thermometer
- Mounts to EVOLUTION, “Fairfield-style” Paladin Medical Equipment Management Rail, using snap action adapter, with positive snap attachment lock feature
- Snap action adapter has tamper proof secured lock feature via allen screws allowing accessory to be tightly locked to equipment rail
- Plate is aluminum with a powder coat anti-microbial painted finish.

940 W. Oakland Ave. Suite A1
Oakland, Florida 34787
Phone: (321) 704-2311
E-Mail: info@PaladinMP.com
Web: www.PaladinMP.com



Paladin Medical Products, LLC
Architectural Solutions for Clinical Environments
— The Fairfield Legacy Company —

Infection Control Devices (IC prefix part numbers)



Evidence Based Design Validation

Harley Ellis Devereaux
Standard Process Handwashing System in Patient Rooms;
All new patient care units

EBD Goal:

To create a standard process that facilitates the practice of appropriate hand washing prior to caregiver interaction with the patient.

Published by The Center for Health Design 2011

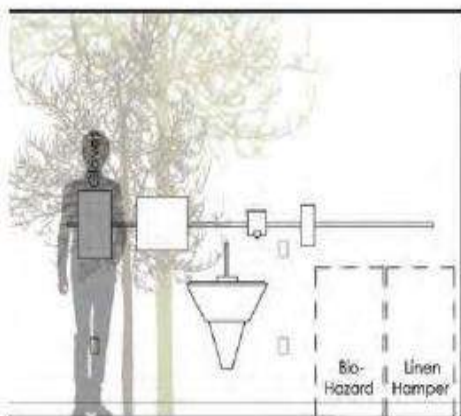
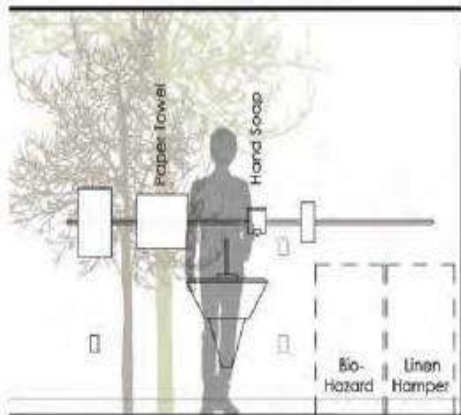
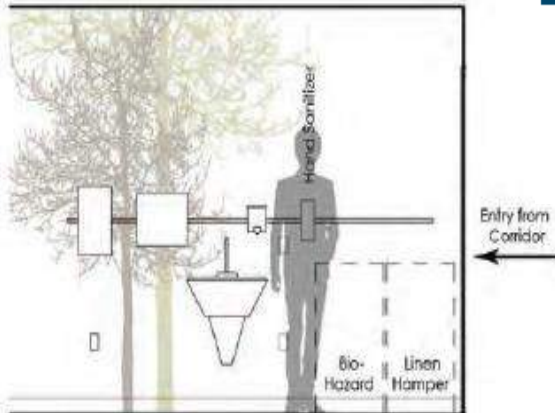

PROBLEM: Per the CDC, many studies have shown that **the bacteria that cause hospital-acquired infections are most frequently spread from one patient to another on the hands of healthcare workers.**

In 34 studies of hand washing, workers washed their hands only 40% of the time.

SOLUTION: Create a standard directional flow with easy access to sink and hand washing accessories at the room entry. **“...placing the hand washing accessories on an equipment rail allows adjustment in the system without creating damage to the wall and potential home for pathogens.”**

PART #	DESCRIPTION
R-205	RAIL, 5'-0"
IC-302	SHARPS CONTAINER AND MOUNT - KENDALL, LARGE
IC-401	PT DISPENSER, TRI-FOLD, MOUNT KIT ONLY
IC-110	SOAP DISPENSER MOUNT
IC-219	GLOVES DISPENSER AND MOUNT
IC-103	HAND FOAM

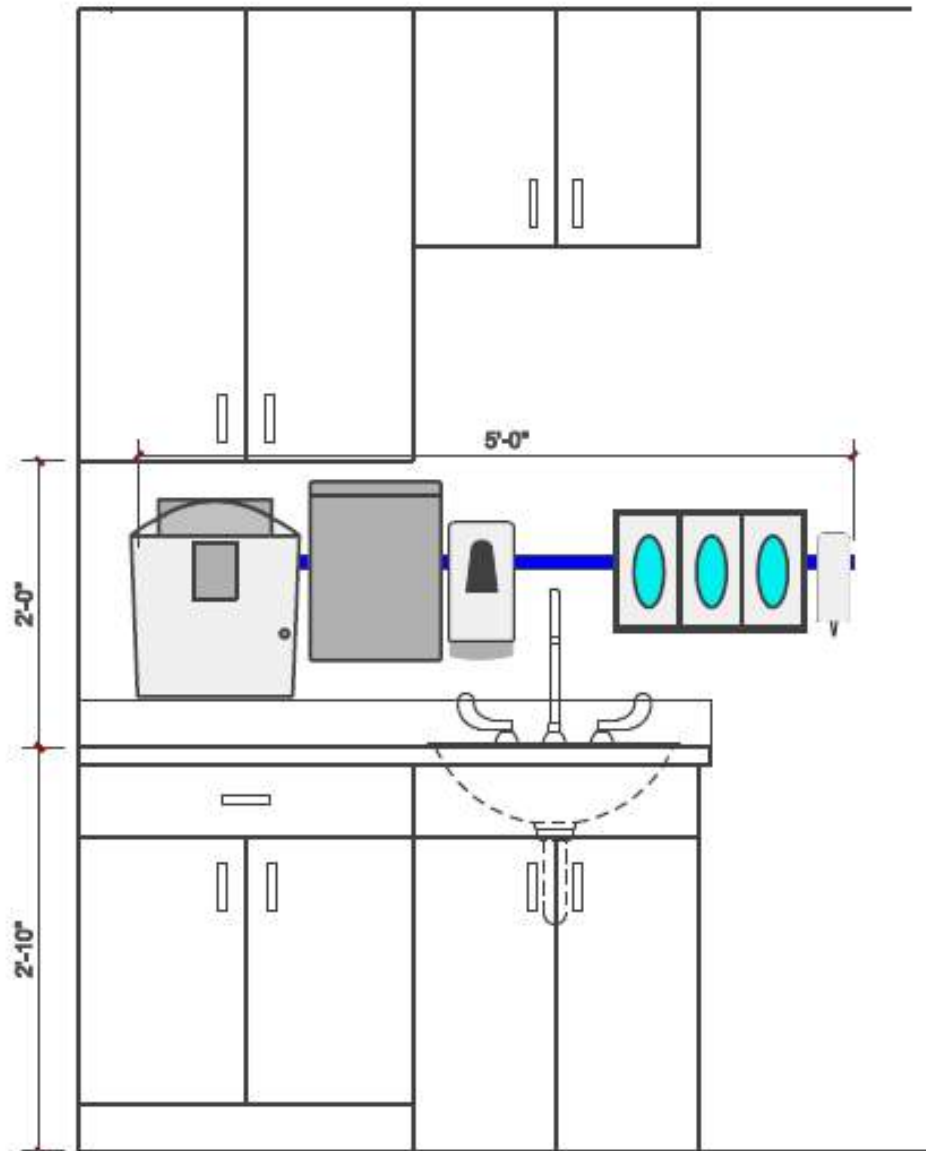

Paladin Medical Products
 Architectural Solutions for Clinical Environments
 — The Fairfield Legacy Company —

940 W. Oakland Avenue, Suite A1
 Oakland, FL 34787
 (407) 614-8781 ph
 gschindeler@paladinmmp.com

**TYPICAL
 INFECTION CONTROL
 AT SINK**

SCALE: N.T.S.
 DATE: 04-22-14

TP.IC
 SHEET NO.

COPYRIGHT © 2013 BY PALADIN MEDICAL PRODUCTS. ALL RIGHTS RESERVED. THIS DOCUMENT IS THE PROPERTY OF PALADIN MEDICAL PRODUCTS. IT IS TO BE USED ONLY FOR INFORMATIONAL PURPOSES OR FOR THE SPECIFIC PROJECT IDENTIFIED OR REFERRED TO HEREIN AND IS NOT TO BE USED ON OTHER PROJECTS OR FOR EXTENSIONS TO THIS PROJECT, IN WHOLE OR IN PART, EXCEPT BY EXPRESS WRITTEN AGREEMENT WITH AND COMPENSATION TO PALADIN MEDICAL PRODUCTS.

**PACKAGE: NOT FOR
 CONSTRUCTION**

PART NUMBER: IC-117 DESCRIPTION: Adapter and universal mount for hand foam canister and drip pan

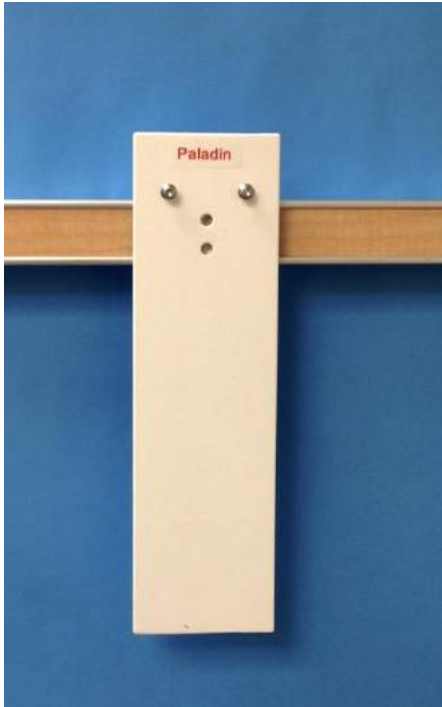

- Designed to hold a variety of foam dispensers made from various manufacturers, including 9 ounce and 17 ounce sizes.
- Mounts to EVOLUTION, “Fairfield-style” Paladin Medical Equipment Management Rail, using snap action adapter, with positive snap attachment lock feature
- Snap action adapter has tamper proof secured lock feature via allen screws allowing accessory to be tightly locked to equipment rail
- Plate is aluminum with a powder coat anti-microbial painted finish.



PART NUMBER: **IC-110**

DESCRIPTION: **Universal mounting plate for hand pump soap/foam dispensers**

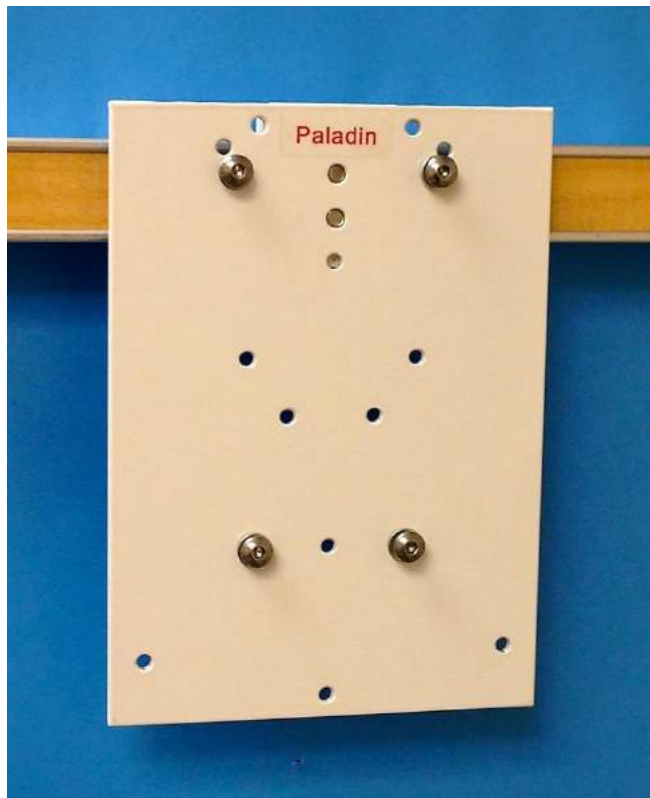

- Designed to hold a variety of hand soap and foam dispensers provided by the owner from various manufacturers
- Mounts to EVOLUTION, “Fairfield-style” Paladin Medical Equipment Management Rail, using snap action adapter, with positive snap attachment lock feature
- Snap action adapter has tamper proof secured lock feature via allen screws allowing accessory to be tightly locked to equipment rail
- Plate is aluminum with a powder coat anti-microbial painted finish.

940 W. Oakland Ave. Suite A1
Oakland, Florida 34787
Phone: (321) 704-2311
E-Mail: info@PaladinMP.com
Web: www.PaladinMP.com



Paladin Medical Products, LLC
Architectural Solutions for Clinical Environments
— The Fairfield Legacy Company —

PART NUMBER: IC-110DA **DESCRIPTION: Universal mounting plate with hand pump soap/foam dispenser factory attached**

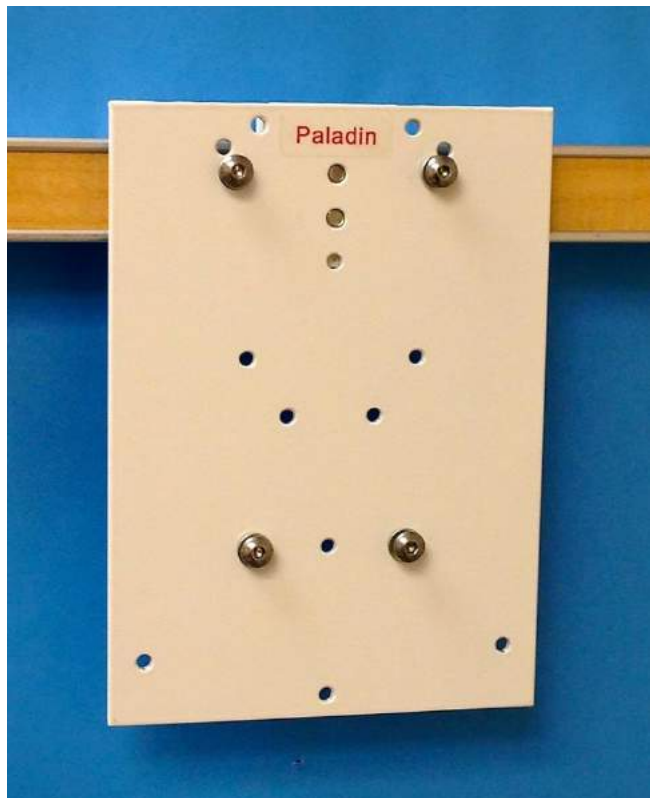

- IC-110 plate for dispensers provided by Paladin from various manufacturers already installed at the Paladin manufacturing facility.
- Mounts to EVOLUTION, “Fairfield-style” Paladin Medical Equipment Management Rail, using snap action adapter, with positive snap attachment lock feature
- Snap action adapter has tamper proof secured lock feature via allen screws allowing accessory to be tightly locked to equipment rail
- Plate is aluminum with a powder coat anti-microbial finish (AMF).



PART NUMBER: **IC-111**

DESCRIPTION: **Mounting plate for hand pump soap/foam dispensers**



- Designed to hold a variety of thin profile hand soap and foam dispensers provided by the owner from various manufacturers
- Mounts to EVOLUTION, “Fairfield-style” Paladin Medical Equipment Management Rail, using snap action adapter, with positive snap attachment lock feature
- Snap action adapter has tamper proof secured lock feature via allen screws allowing accessory to be tightly locked to equipment rail
- Plate is aluminum with a powder coat painted with an imbedded Anti-Microbial Finish (AMF).

940 W. Oakland Ave. Suite A1
Oakland, Florida 34787
Phone: (321) 704-2311
E-Mail: info@PaladinMP.com
Web: www.PaladinMP.com



Paladin Medical Products, LLC
Architectural Solutions for Clinical Environments
— The Fairfield Legacy Company —

PART NUMBER: IC-112 **DESCRIPTION: Universal/adjustable mount for a variety of hand wipe dispensers**

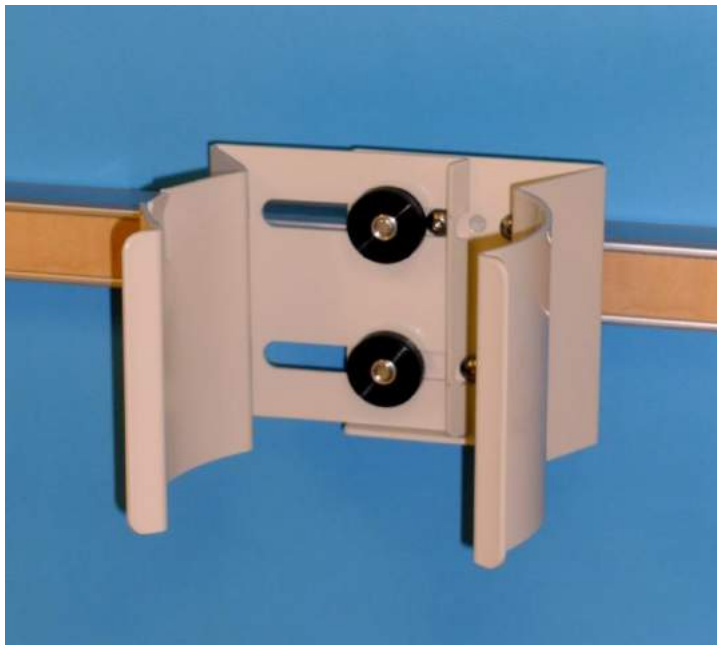

- Designed to hold a variety of cleaning wipe dispensers made from various manufacturers
- Mounts to EVOLUTION, “Fairfield-style” Paladin Medical Equipment Management Rail, using snap action adapter, with positive snap attachment lock feature
- Snap action adapter has tamper proof secured lock feature via allen screws allowing accessory to be tightly locked to equipment rail
- Adjustable bracket is aluminum with a powder coat painted finish and comes complete with adjustable knobs to adapt to a variety of brands

940 W. Oakland Ave. Suite A1
Oakland, Florida 34787
Phone: (321) 704-2311
E-Mail: info@PaladinMP.com
Web: www.PaladinMP.com



Paladin Medical Products, LLC
Architectural Solutions for Clinical Environments
— The Fairfield Legacy Company —

PART NUMBER: **IC-203**

DESCRIPTION: **Holder, “Adjustable”
Triple Glove Box**



- Designed to hold 3 boxes of gloves, any style, designed to field-adjust the width based on different glove box sizes by different manufacturers of gloves
- Mounts to EVOLUTION, “Fairfield-style” Paladin Medical Equipment Management Rail, using snap action adapter, with positive snap attachment lock feature
- Snap action adapter has tamper proof secured lock feature via allen screws allowing accessory to be tightly locked to equipment rail
- Actual box holder is powder coated metal. Details to be specified at time of order based on user preference

940 W. Oakland Ave. Suite A1
Oakland, Florida 34787
Phone: (321) 704-2311
E-Mail: info@PaladinMP.com
Web: www.PaladinMP.com



Paladin Medical Products, LLC
Architectural Solutions for Clinical Environments
— The Fairfield Legacy Company —

PART NUMBER: **IC-206**

DESCRIPTION: **Wire Holder, Vertical
Quad Glove Box, Top Feed**

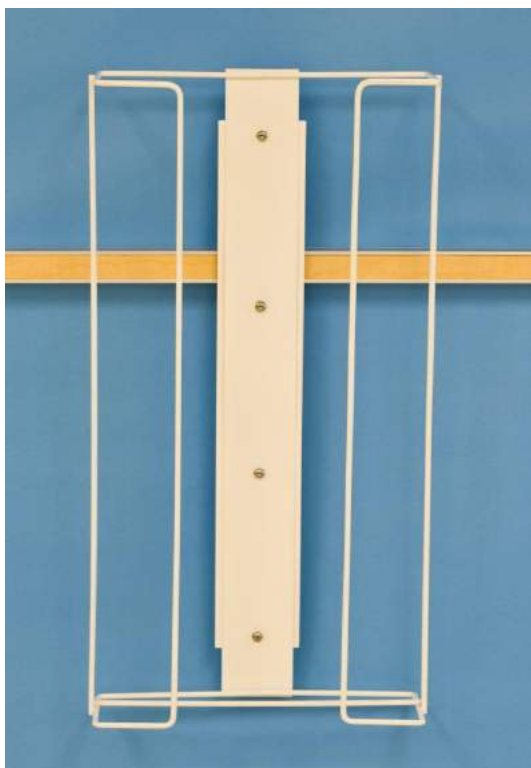

- Gloves holder, vertical, wire coated, 4 box, top feed
- Mounts to EVOLUTION, “Fairfield-style” Paladin Medical Equipment Management Rail, using snap action adapter, with positive snap attachment lock feature
- Snap action adapter has tamper proof secured lock feature via allen screws allowing accessory to be tightly locked to equipment rail
- Options for side load/feed also available

940 W. Oakland Ave. Suite A1
Oakland, Florida 34787
Phone: (321) 704-2311
E-Mail: info@PaladinMP.com
Web: www.PaladinMP.com



Paladin Medical Products, LLC
Architectural Solutions for Clinical Environments
— The Fairfield Legacy Company —

PART NUMBER: **IC-208**

DESCRIPTION: **Wire Holder, Horizontal
Triple Glove Box, Top Feed**



- Designed to hold 3 boxes of gloves, any style top feed. May be mounted horizontally or vertically
- Mounts to EVOLUTION, “Fairfield-style” Paladin Medical Equipment Management Rail, using snap action adapter, with positive snap attachment lock feature
- Snap action adapter has tamper proof secured lock feature via allen screws allowing accessory to be tightly locked to equipment rail
- Actual box holder is wire. Details to be specified at time of order based on user preference.

940 W. Oakland Ave. Suite A1
Oakland, Florida 34787
Phone: (321) 704-2311
E-Mail: info@PaladinMP.com
Web: www.PaladinMP.com



Paladin Medical Products, LLC
Architectural Solutions for Clinical Environments
— The Fairfield Legacy Company —

PART NUMBER: IC-219, Horizontal
PART NUMBER: IC-226, Vertical

**DESCRIPTION: ABS Plastic Triple
Gloves Box Holder**



- Designed to hold 3 boxes of gloves, any style top feed and durable ABS plastic and has physical dividers between gloves slots. Top feed for horizontal; side feed for vertical.
- Mounts to EVOLUTION, “Fairfield-style” Paladin Medical Equipment Management Rail, using snap action adapter, with positive snap attachment lock feature
- Snap action adapter has tamper proof secured lock feature via allen screws allowing accessory to be tightly locked to equipment rail
- Back plate mount is aluminum with a powder coat anti-microbial painted finish.

940 W. Oakland Ave. Suite A1
Oakland, Florida 34787
Phone: (321) 704-2311
E-Mail: info@PaladinMP.com
Web: www.PaladinMP.com



Paladin Medical Products, LLC
Architectural Solutions for Clinical Environments
— The Fairfield Legacy Company —

PART NUMBER: IC-227, Horizontal
PART NUMBER: IC-229, Vertical (shown)

DESCRIPTION: ABS Plastic,
Single Glove Box Holder,
Maple Wood Finish



- Designed to hold 1 box of gloves, any style. Top feed for vertical; side feed for horizontal. (Also available in dark Cherry finish, not shown.)
- Mounts to EVOLUTION, “Fairfield-style” Paladin Medical Equipment Management Rail, using snap action adapter, with positive snap attachment lock feature
- Snap action adapter has tamper proof secured lock feature via allen screws allowing accessory to be tightly locked to equipment rail
- Back plate mount is aluminum with a powder coat anti-microbial painted finish.

940 W. Oakland Ave. Suite A1
Oakland, Florida 34787
Phone: (321) 704-2311
E-Mail: info@PaladinMP.com
Web: www.PaladinMP.com



Paladin Medical Products, LLC
Architectural Solutions for Clinical Environments
— The Fairfield Legacy Company —

PART NUMBER: IC-235, Horizontal
PART NUMBER: IC-237, Vertical

DESCRIPTION: ABS Plastic, Triple
Glove Box Holder, Maple Wood
Finish



- Designed to hold 3 boxes of gloves, any style. Top feed for horizontal; side feed for vertical. (Also available in dark Cherry finish, not shown.)
- Mounts to EVOLUTION, “Fairfield-style” Paladin Medical Equipment Management Rail, using snap action adapter, with positive snap attachment lock feature
- Snap action adapter has tamper proof secured lock feature via allen screws allowing accessory to be tightly locked to equipment rail
- Back plate mount is aluminum with a powder coat anti-microbial painted finish.

940 W. Oakland Ave. Suite A1
Oakland, Florida 34787
Phone: (321) 704-2311
E-Mail: info@PaladinMP.com
Web: www.PaladinMP.com



Paladin Medical Products, LLC
Architectural Solutions for Clinical Environments
— The Fairfield Legacy Company —

PART NUMBER: IC-303

DESCRIPTION: Adapter and mounting plate for various locking Sharps container

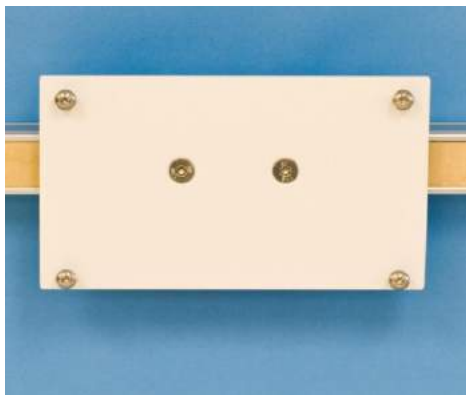

- Designed to hold a standard size Kendall or BD style sharps locking container
- Mounts to EVOLUTION, “Fairfield-style” Paladin Medical Equipment Management Rail, using snap action adapter, with positive snap attachment lock feature
- Snap action adapter has tamper proof secured lock feature via allen screws allowing accessory to be tightly locked to equipment rail
- Plate is aluminum with a powder coat anti-microbial painted finish

940 W. Oakland Ave. Suite A1
Oakland, Florida 34787
Phone: (321) 704-2311
E-Mail: info@PaladinMP.com
Web: www.PaladinMP.com



Paladin Medical Products, LLC
Architectural Solutions for Clinical Environments
— The Fairfield Legacy Company —

PART NUMBER: IC-305

DESCRIPTION: Adapter and mounting plate for typical large sharps containers



- Designed to hold most brands of large capacity sharps containers
- Mounts to EVOLUTION, “Fairfield-style” Paladin Medical Equipment Management Rail, using snap action adapter, with positive snap attachment lock feature
- Snap action adapter has tamper proof secured lock feature via allen screws allowing accessory to be tightly locked to equipment rail
- Plate is aluminum with a powder coat anti-microbial painted finish, drilled and tapped for the appropriate hole pattern on the sharps container

940 W. Oakland Ave. Suite A1
Oakland, Florida 34787
Phone: (321) 704-2311
E-Mail: info@PaladinMP.com
Web: www.PaladinMP.com



Paladin Medical Products, LLC
Architectural Solutions for Clinical Environments
— The Fairfield Legacy Company —

PART NUMBER: IC-401

DESCRIPTION: Adapter for standard tri-fold paper towel holder



- Designed to attach to existing mounting holes of most tri-fold paper towel dispensers
- Mounts to EVOLUTION, “Fairfield-style” Paladin Medical Equipment Management Rail, using snap action adapter, with positive snap attachment lock feature
- Snap action adapter has tamper proof secured lock feature via allen screws allowing accessory to be tightly locked to equipment rail

940 W. Oakland Ave. Suite A1
Oakland, Florida 34787
Phone: (321) 704-2311
E-Mail: info@PaladinMP.com
Web: www.PaladinMP.com



Paladin Medical Products, LLC
Architectural Solutions for Clinical Environments
— The Fairfield Legacy Company —

PART NUMBER: **IC-405**

DESCRIPTION: **Adapter and mounting plate for Georgia Pacific en-Motion paper towel holder**



- Designed to hold a large roll paper towel dispenser such as enMotion or Kimberly Clark pull down style
- Mounts to EVOLUTION, “Fairfield-style” Paladin Medical Equipment Management Rail, using snap action adapter, with positive snap attachment lock feature
- Snap action adapter has tamper proof secured lock feature via allen screws allowing accessory to be tightly locked to equipment rail
- The plate is aluminum with a powder coat anti-microbial painted finish.

940 W. Oakland Ave. Suite A1
Oakland, Florida 34787
Phone: (321) 704-2311
E-Mail: info@PaladinMP.com
Web: www.PaladinMP.com



Paladin Medical Products, LLC
Architectural Solutions for Clinical Environments
— The Fairfield Legacy Company —

PART NUMBER: IC-413

**DESCRIPTION: Adapter and mounting plate
for Kimberly Clark IN-SIGHT center
pull-down paper towel holder**



- Designed to hold a large roll paper towel dispenser such as Kimberly Clark pull down product code 09335.
- Mounts to EVOLUTION, “Fairfield-style” Paladin Medical Equipment Management Rail, using snap action adapter, with positive snap attachment lock feature
- Snap action adapter has tamper proof secured lock feature via allen screws allowing accessory to be tightly locked to equipment rail
- Plate is aluminum with a powder coat anti-microbial painted finish

940 W. Oakland Ave. Suite A1
Oakland, Florida 34787
Phone: (321) 704-2311
E-Mail: info@PaladinMP.com
Web: www.PaladinMP.com



Paladin Medical Products, LLC
Architectural Solutions for Clinical Environments
— The Fairfield Legacy Company —

Miscellaneous Accessories



PART NUMBER: SM-101 DESCRIPTION: “U” Shaped BP Cuff basket



- Designed to hold a variety of blood pressure cuffs
- Mounts to EVOLUTION, “Fairfield-style” Paladin Medical Equipment Management Rail, using snap action adapter, with positive snap attachment lock feature
- Snap action adapter has tamper proof secured lock feature via allen screws allowing accessory to be tightly locked to equipment rail
- Basket is wire-form construction with a durable nylon finish to facilitate cleanliness. Basket shall include one snap-action adapter for mounting to rail.



PART NUMBER: SM-102

DESCRIPTION: Small wire basket



- Designed to hold a variety of supplies. Dimensions are 10" X 4" X 6"
- Mounts to EVOLUTION, "Fairfield-style" Paladin Medical Equipment Management Rail, using snap action adapter, with positive snap attachment lock feature
- Snap action adapter has tamper proof secured lock feature via allen screws allowing accessory to be tightly locked to equipment rail
- Basket is wire-form construction with a durable nylon finish to facilitate cleanliness. Basket shall include one snap-action adapter for mounting to rail.

940 W. Oakland Ave. Suite A1
Oakland, Florida 34787
Phone: (321) 704-2311
E-Mail: info@PaladinMP.com
Web: www.PaladinMP.com



Paladin Medical Products, LLC
Architectural Solutions for Clinical Environments
— The Fairfield Legacy Company —

PART NUMBER: **SM-103**

DESCRIPTION: **Large wire basket with adjustable dividers**



- Designed to hold a variety of supplies. Dimensions are 16"X 9"X5". Includes 3 adjustable dividers for user definition of storage space
- Mounts to EVOLUTION, "Fairfield-style" Paladin Medical Equipment Management Rail, using snap action adapter, with positive snap attachment lock feature
- Snap action adapter has tamper proof secured lock feature via allen screws allowing accessory to be tightly locked to equipment rail
- Basket is wire-form construction with a durable nylon finish to facilitate cleanliness. Basket shall include one snap-action adapter for mounting to rail.

940 W. Oakland Ave. Suite A1
Oakland, Florida 34787
Phone: (321) 704-2311
E-Mail: info@PaladinMP.com
Web: www.PaladinMP.com



Paladin Medical Products, LLC
Architectural Solutions for Clinical Environments
— The Fairfield Legacy Company —

PART NUMBER: **SM-201**

DESCRIPTION: **Storage bins (3) with clear front**



- 3 storage bins container with clear plastic front, hinged for easy fold out and access
- Mounts to EVOLUTION, “Fairfield-style” Paladin Medical Equipment Management Rail, using snap action adapter, with positive snap attachment lock feature
- Snap action adapter has tamper proof secured lock feature via allen screws allowing accessory to be tightly locked to equipment rail
- Bins mounted in two places with Paladin adapters for stable mounting

940 W. Oakland Ave. Suite A1
Oakland, Florida 34787
Phone: (321) 704-2311
E-Mail: info@PaladinMP.com
Web: www.PaladinMP.com



Paladin Medical Products, LLC
Architectural Solutions for Clinical Environments
— The Fairfield Legacy Company —

PART NUMBER: **SM-202**

DESCRIPTION: **Storage bins (4) with clear front**



- 4 storage bin container with clear plastic front, hinged for easy fold out and access
- Mounts to EVOLUTION, “Fairfield-style” Paladin Medical Equipment Management Rail, using snap action adapter, with positive snap attachment lock feature
- Snap action adapter has tamper proof secured lock feature via allen screws allowing accessory to be tightly locked to equipment rail
- Bins mounted in two places with Paladin adapters for stable mounting

940 W. Oakland Ave. Suite A1
Oakland, Florida 34787
Phone: (321) 704-2311
E-Mail: info@PaladinMP.com
Web: www.PaladinMP.com



Paladin Medical Products, LLC
Architectural Solutions for Clinical Environments
— The Fairfield Legacy Company —

PART NUMBER: SM-203

**DESCRIPTION: Storage bins (5)
with clear front**



- 5 storage bins container with clear plastic front, hinged for easy fold out and access
- Mounts to EVOLUTION, “Fairfield-style” Paladin Medical Equipment Management Rail, using snap action adapter, with positive snap attachment lock feature
- Snap action adapter has tamper proof secured lock feature via allen screws allowing accessory to be tightly locked to equipment rail
- Bins mounted in two places with Paladin adapters for stable mounting

940 W. Oakland Ave. Suite A1
Oakland, Florida 34787
Phone: (321) 704-2311
E-Mail: info@PaladinMP.com
Web: www.PaladinMP.com



Paladin Medical Products, LLC
Architectural Solutions for Clinical Environments
— The Fairfield Legacy Company —

PART NUMBER: SM-206

DESCRIPTION: Catheter Container with 2 Dividers, 6" x 4" x 18", with clear front

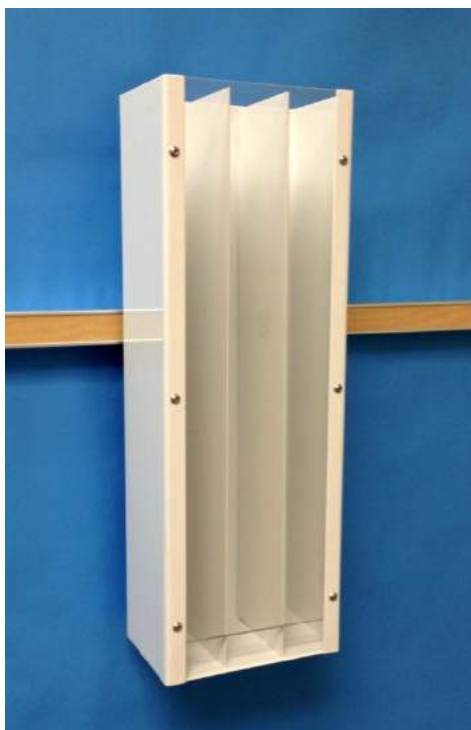

- Long container for storage of catheters, 3 equally spaced dividers
- Mounts to EVOLUTION, “Fairfield-style” Paladin Medical Equipment Management Rail, using snap action adapter, with positive snap attachment lock feature
- Snap action adapter has tamper proof secured lock feature via allen screws allowing accessory to be tightly locked to equipment rail
- Clear Plexiglas front for easy viewing, open space at bottom for easy cleaning and reach of smaller items.
- Container is aluminum with a powder coat anti-microbial painted finish.

940 W. Oakland Ave. Suite A1
Oakland, Florida 34787
Phone: (321) 704-2311
E-Mail: info@PaladinMP.com
Web: www.PaladinMP.com



Paladin Medical Products, LLC
Architectural Solutions for Clinical Environments
— The Fairfield Legacy Company —

PART NUMBER: **SM-301**

DESCRIPTION: **Single Utility hook**



- Single hook designed to hold a variety of items from a single hook
- Mounts to EVOLUTION, “Fairfield-style” Paladin Medical Equipment Management Rail, using snap action adapter, with positive snap attachment lock feature
- Snap action adapter has tamper proof secured lock feature via allen screws allowing accessory to be tightly locked to equipment rail
- Hook is stainless steel and welded to a back plate. Entire assembly is finished with a powder coat anti-microbial painted finish.

940 W. Oakland Ave. Suite A1
Oakland, Florida 34787
Phone: (321) 704-2311
E-Mail: info@PaladinMP.com
Web: www.PaladinMP.com



Paladin Medical Products, LLC
Architectural Solutions for Clinical Environments
— The Fairfield Legacy Company —

PART NUMBER: **SM-302**

DESCRIPTION: **Triple utility hook**

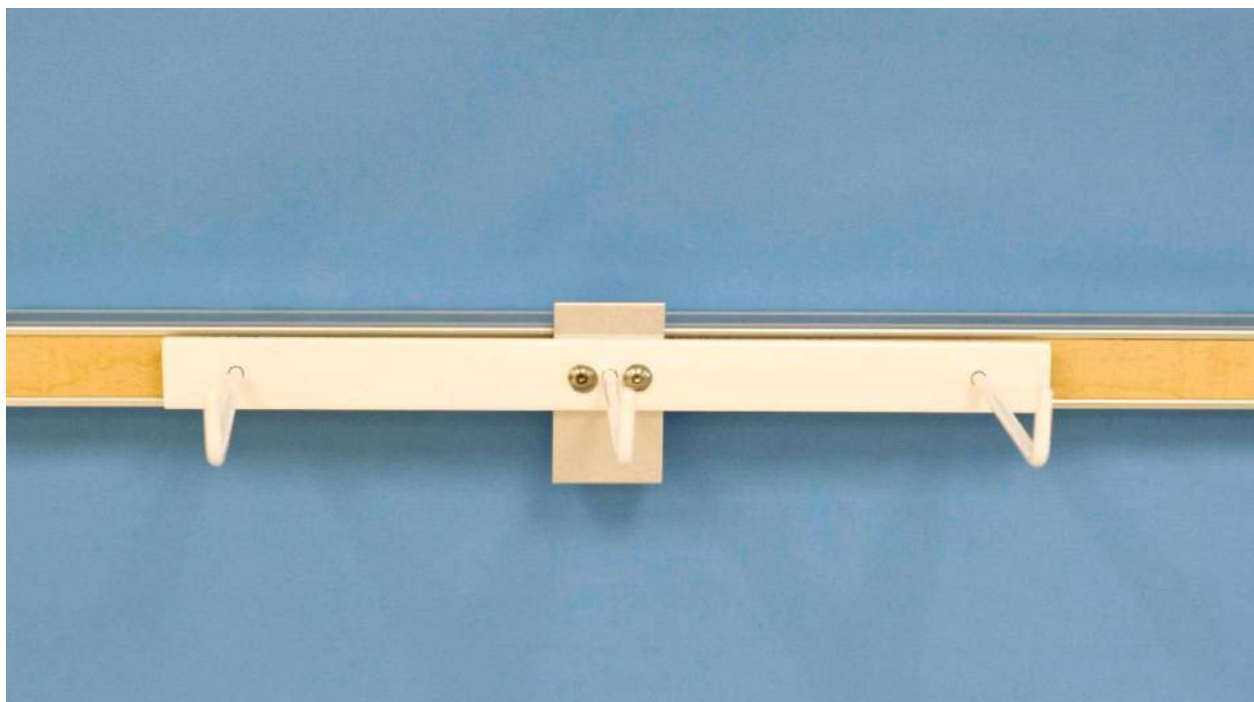

- Triple hooks designed to hold a variety of items from a single or multiple hook
- Mounts to EVOLUTION, “Fairfield-style” Paladin Medical Equipment Management Rail, using snap action adapter, with positive snap attachment lock feature
- Snap action adapter has tamper proof secured lock feature via allen screws allowing accessory to be tightly locked to equipment rail
- Hooks are stainless steel and welded to a back plate. The entire assembly has a powder coat anti-microbial painted finish.

940 W. Oakland Ave. Suite A1
Oakland, Florida 34787
Phone: (321) 704-2311
E-Mail: info@PaladinMP.com
Web: www.PaladinMP.com



Paladin Medical Products, LLC
Architectural Solutions for Clinical Environments
— The Fairfield Legacy Company —

PART NUMBER: SM-304 DESCRIPTION: Rail Mounted Cord Bundler



- Flexible cord bundle tie for use with patient cables and power cords. Single hand use, washable and durable
- Mounts to EVOLUTION, “Fairfield-style” Paladin Medical Equipment Management Rail, using snap action adapter, with positive snap attachment lock feature
- Snap action adapter has tamper proof secured lock feature via allen screws allowing accessory to be tightly locked to equipment rail



PART NUMBER: **SM-401**

DESCRIPTION: **6 clip organizer**



- 6 clips mounted on a horizontal bar, held in two places on the rail
- Mounts to EVOLUTION, “Fairfield-style” Paladin Medical Equipment Management Rail, using snap action adapter, with positive snap attachment lock feature
- Snap action adapter has tamper proof secured lock feature via allen screws allowing accessory to be tightly locked to equipment rail.
- The plate is aluminum with a powder coat anti-microbial painted finish

940 W. Oakland Ave. Suite A1
Oakland, Florida 34787
Phone: (321) 704-2311
E-Mail: info@PaladinMP.com
Web: www.PaladinMP.com



Paladin Medical Products, LLC
Architectural Solutions for Clinical Environments
— The Fairfield Legacy Company —

PART NUMBER: **SM-406**

DESCRIPTION: **12" Paper Display Rail for holding individual sheets of paper**



- 12" friction mounting rail to hold a single sheet of paper for in-room and hallway notifications
- Mounts to EVOLUTION, "Fairfield-style" Paladin Medical Equipment Management Rail, using snap action adapter, with positive snap attachment lock feature
- Snap action adapter has tamper proof secured lock feature via allen screws allowing accessory to be tightly locked to equipment rail.
- The back plate is aluminum with a powder coat anti-microbial painted finish

940 W. Oakland Ave. Suite A1
Oakland, Florida 34787
Phone: (321) 704-2311
E-Mail: info@PaladinMP.com
Web: www.PaladinMP.com



Paladin Medical Products, LLC
Architectural Solutions for Clinical Environments
— The Fairfield Legacy Company —

PART NUMBER: **S-216**

DESCRIPTION: **Shelf, folding, 10" x 15"**

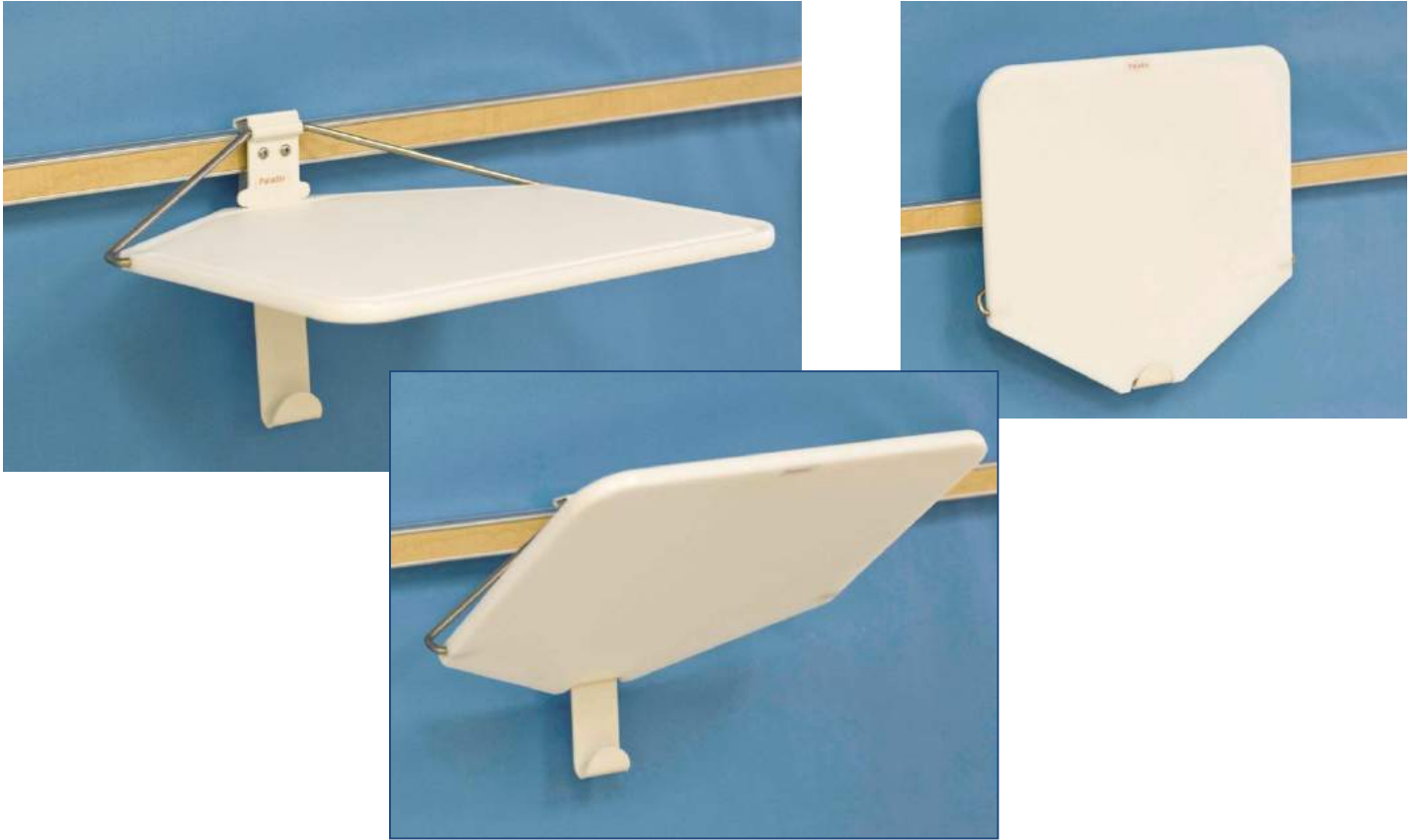

- Fold down shelf, 10" x 15". Single handed operation
- Mounts to EVOLUTION, "Fairfield-style" Paladin Medical Equipment Management Rail, using snap action adapter, with positive snap attachment lock feature
- Snap action adapter has tamper proof secured lock feature via allen screws allowing accessory to be tightly locked to equipment rail
- Shelf is made of polypropylene and has a milled groove around the perimeter to keep fluids and small articles from rolling off

940 W. Oakland Ave. Suite A1
Oakland, Florida 34787
Phone: (321) 704-2311
E-Mail: info@PaladinMP.com
Web: www.PaladinMP.com



Paladin Medical Products, LLC
Architectural Solutions for Clinical Environments
— The Fairfield Legacy Company —

PART NUMBER: **SM-303**

DESCRIPTION: **Rail mount for
Lead Apron**

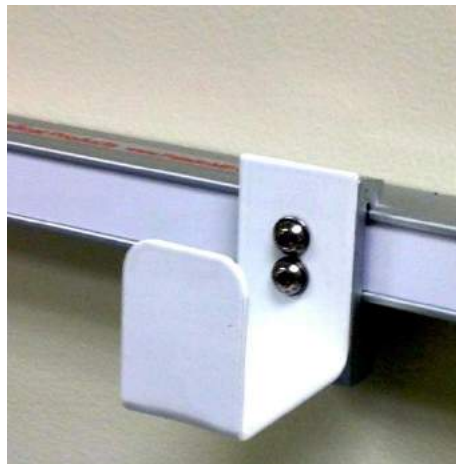

- Hook to support the hanging of lead aprons in any applicable environment.
- Mounts to EVOLUTION, “Fairfield-style” Paladin Medical Equipment Management Rail, using snap action adapter, with positive snap attachment lock feature
- Snap action adapter has tamper proof secured lock feature via allen screws allowing accessory to be tightly locked to equipment rail
- The hook is steel with a powder coat anti-microbial painted finish

940 W. Oakland Ave. Suite A1
Oakland, Florida 34787
Phone: (321) 704-2311
E-Mail: info@PaladinMP.com
Web: www.PaladinMP.com



Paladin Medical Products, LLC
Architectural Solutions for Clinical Environments
— The Fairfield Legacy Company —

PART NUMBER: **GCX 101/102**

DESCRIPTION: **GCX channel with adapters for rail mount**



- GCX mounting channel for use with monitor and computer mounting arms
- Mounts to EVOLUTION, “Fairfield-style” Paladin Medical Equipment Management Rail, using snap action adapter, with positive snap attachment lock feature
- Snap action adapter has tamper proof secured lock feature via allen screws allowing accessory to be tightly locked to equipment rail
- Variable mounting lengths are available to serve a variety of applications

940 W. Oakland Ave. Suite A1
Oakland, Florida 34787
Phone: (321) 704-2311
E-Mail: info@PaladinMP.com
Web: www.PaladinMP.com



Paladin Medical Products, LLC
Architectural Solutions for Clinical Environments
— The Fairfield Legacy Company —

PART NUMBER: AC-101

**DESCRIPTION: Vacuum Bottle Slide,
Universal Size**



- Designed to hold a variety of vacuum bottles made from various manufacturers. Slide profile is an industry standard
- Mounts to Paladin Medical Equipment Management Rail, Fairfield "style" using snap action adapter, with positive snap attachment lock feature
- Snap action adapter has tamper proof secured lock feature via allen screws allowing accessory to be tightly locked to equipment rail
- Vacuum Bottle slide is aluminum with an anodized finish

940 W. Oakland Ave. Suite A1
Oakland, Florida 34787
Phone: (321) 704-2311
E-Mail: info@PaladinMP.com
Web: www.PaladinMP.com



Paladin Medical Products, LLC
Architectural Solutions for Clinical Environments
— The Fairfield Legacy Company —

PART NUMBER: OGB-101 DESCRIPTION: Medical Gas Block, Oxygen

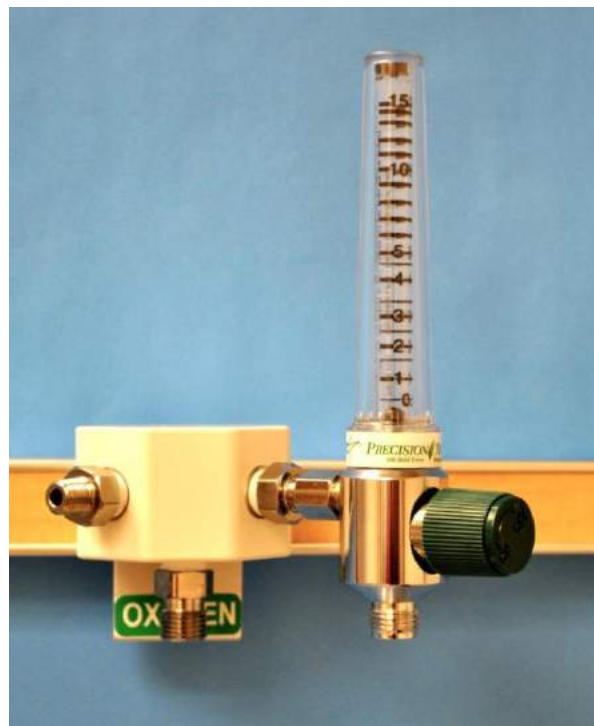
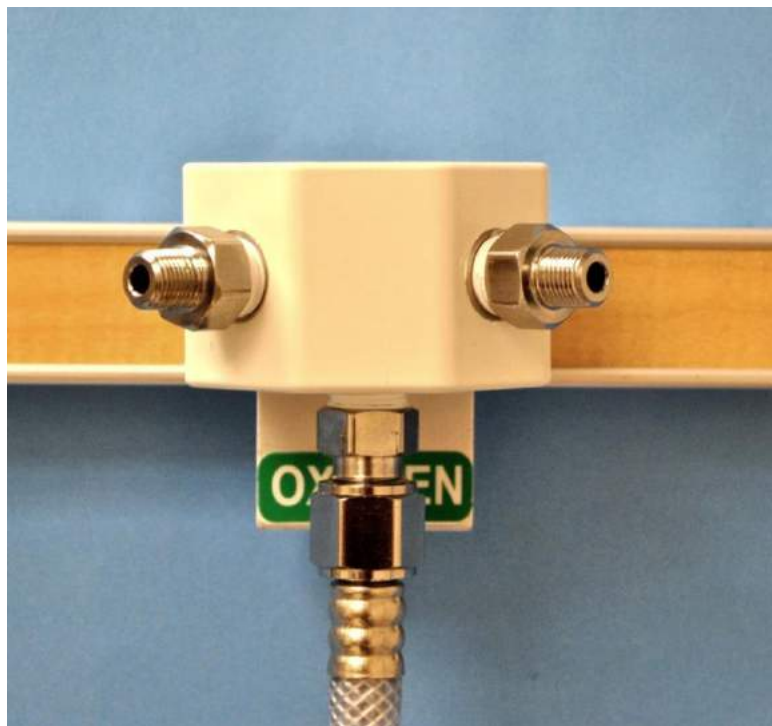

- Medical Gas expansion block for multiplexing gas outlets on the rail
- Mounts to EVOLUTION, “Fairfield-style” Paladin Medical Equipment Management Rail, using snap action adapter, with positive snap attachment lock feature
- Snap action adapter has tamper proof secured lock feature via allen screws allowing accessory to be tightly locked to equipment rail
- Available in multiple fitting styles
- Available in Air, Oxygen, Vacuum and custom gasses for specialty application

940 W. Oakland Ave. Suite A1
Oakland, Florida 34787
Phone: (321) 704-2311
E-Mail: info@PaladinMP.com
Web: www.PaladinMP.com



Paladin Medical Products, LLC
Architectural Solutions for Clinical Environments
— The Fairfield Legacy Company —

PART NUMBER: HTO-101 **DESCRIPTION: Tank Holder, for size D or E**



- Tank holder, Stainless steel, for holding a variety of tanks in either the D or E size.
- Mounts to EVOLUTION, “Fairfield-style” Paladin Medical Equipment Management Rail, using a double snap action adapter, with positive snap attachment lock feature
- Snap action adapter has tamper proof secured lock feature via allen screws allowing accessory to be tightly locked to equipment rail

940 W. Oakland Ave. Suite A1
Oakland, Florida 34787
Phone: (321) 704-2311
E-Mail: info@PaladinMP.com
Web: www.PaladinMP.com



Paladin Medical Products, LLC
Architectural Solutions for Clinical Environments
— The Fairfield Legacy Company —

PART NUMBER: LM-101

**DESCRIPTION: Kit for Rail Mounting
Waldmann LED flex arm light**

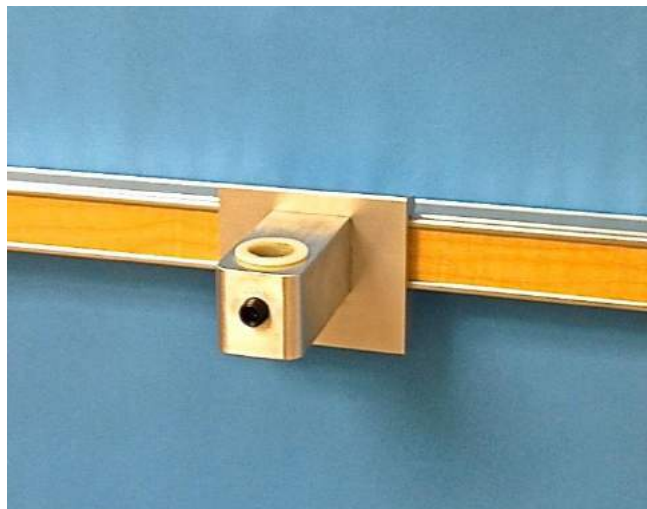

- Mounting kit for the Waldmann LED light, 1" diameter hole, allen wrench set screw.
- Mounts to EVOLUTION, "Fairfield-style" Paladin Medical Equipment Management Rail, using a double snap action adapter, with positive snap attachment lock feature
- Snap action adapter has tamper proof secured lock feature via allen screws allowing accessory to be tightly locked to equipment rail.
- Post holder mount is aluminum with Paladin AMF (Anti-Microbial Finish) painted finish.

940 W. Oakland Ave. Suite A1
Oakland, Florida 34787
Phone: (321) 704-2311
E-Mail: info@PaladinMP.com
Web: www.PaladinMP.com



Paladin Medical Products, LLC
Architectural Solutions for Clinical Environments
— The Fairfield Legacy Company —

PART NUMBER: **IM-303**

DESCRIPTION: **IV Swing arm holder with a 4 hook IV bag hanger**

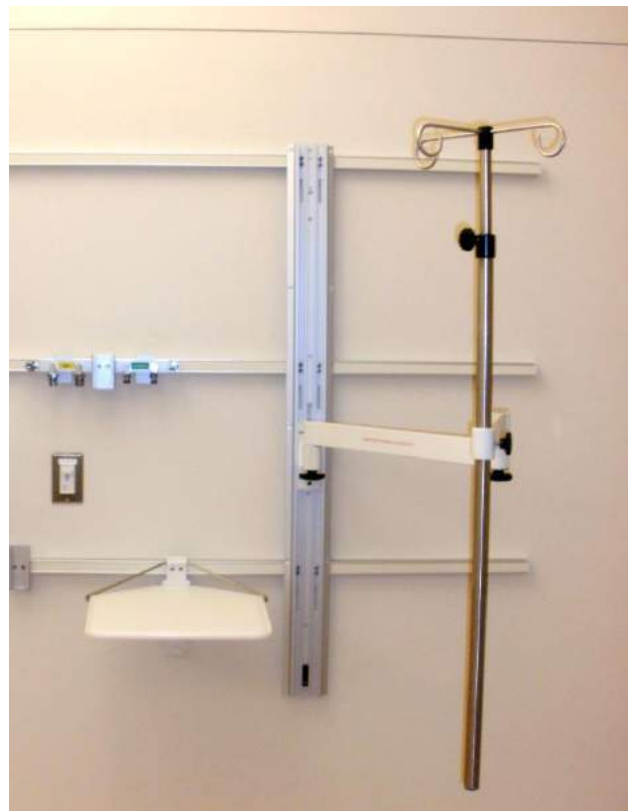

- Infusion pump mounting swing arm for attachment of infusion pumps and other pole mount devices.
- Mounts to either a GCX channel or a 38mm pole.
GCX OR POLE MOUNT MUST BE PURCHASED SEPERATELY
- A combination of 12" and 20" arms with double articulating knuckles
- Includes a 36" pole 1" diameter, and an 36" extension I.V. Pole with a 4 hook hanger All poles are adjustable for optimal height.
- All arm surfaces are aluminum with Paladin AMF (Anti-Microbial Finish) painted finish

940 W. Oakland Ave. Suite A1
Oakland, Florida 34787
Phone: (321) 704-2311
E-Mail: info@PaladinMP.com
Web: www.PaladinMP.com



Paladin Medical Products, LLC
Architectural Solutions for Clinical Environments
— The Fairfield Legacy Company —

PART NUMBER: IM-403

**DESCRIPTION: Infusion Pump holder
(2 positions) with a 4 hook IV bag hanger**



- Infusion pump mounting 2 position, for attachment of infusion pumps and other pole mount devices.
- Mounts to Fairfield-style rail held in two places with Paladin AMF (Anti-Microbial Finish) brackets.
- A combination of 12" and 20" arms with double articulating knuckles.
- Includes a 36" pole 1" diameter, and an 36" adjustable extension I.V. Pole with a 4 hook hanger.
- All poles are adjustable for optimal height.

940 W. Oakland Ave. Suite A1
Oakland, Florida 34787
Phone: (321) 704-2311
E-Mail: info@PaladinMP.com
Web: www.PaladinMP.com



Paladin Medical Products, LLC
Architectural Solutions for Clinical Environments
— The Fairfield Legacy Company —

PART NUMBER:

DESCRIPTION: **Mounting kit for standard wall hung telephone**



- Rail mounting plate for a standard wall mount telephone
- Mounts to Fairfield Style Rail with Paladin AMF (Anti-Microbial Finish) snap adapter bracket.
- Comes complete with a universal key hole plate which matches standard telephone hole patterns

940 W. Oakland Ave. Suite A1
Oakland, Florida 34787
Phone: (321) 704-2311
E-Mail: info@PaladinMP.com
Web: www.PaladinMP.com



Paladin Medical Products, LLC
Architectural Solutions for Clinical Environments
— The Fairfield Legacy Company —

Applications



Paladin Medical Products, LLC
Architectural Solutions for Clinical Environments
— The Fairfield Legacy Company —

Applications



Paladin Medical Products, LLC
Architectural Solutions for Clinical Environments
— The Fairfield Legacy Company —



Infection Control Solution:
3" Evolution rail at all door
positions for hand foam



Paladin Medical Products, LLC

Architectural Solutions for Clinical Environments

— The Fairfield Legacy Company —



Wood grain laminate
in-lay to
complement millwork



Paladin Medical Products, LLC

Architectural Solutions for Clinical Environments

— The Fairfield Legacy Company —

Applications



Paladin Medical Products, LLC

Architectural Solutions for Clinical Environments

— The Fairfield Legacy Company —

Rail and Accessories in the patient room for **Lean Inventory Management and Improved Infection Control**



Paladin Medical Products, LLC

Architectural Solutions for Clinical Environments

— The Fairfield Legacy Company —



**Paladin
Medical
Products**

(407) 614-8781 office
info@PaladinMP.com

CHALLENGE

The day after open house, medical facilities are besieged with clinical operations realities. Often times the critical management tools were “Value Engineered” out of the project, leaving the staff to work around and “deal with” what’s in place. They have no means to define and manage the space and equipment they need.



STOP “DEALING WITH IT” MANAGE YOUR WORKSPACE

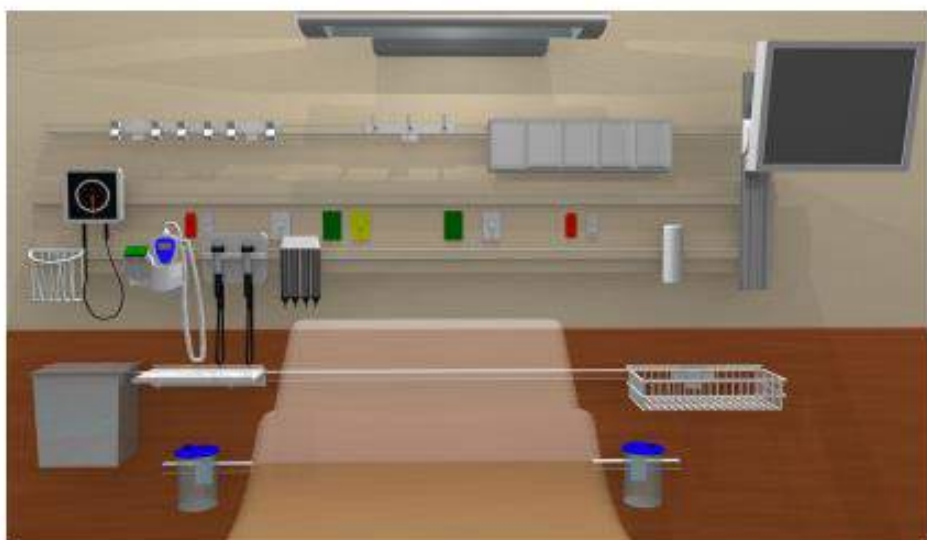

SOLUTION

Utilizing the “Evolution” Medical Equipment Rail Management System empowers the Clinical Staff to easily adapt and make changes to what’s fixed in place. They can create and define an optimum working environment without additional construction.

Furthermore, a neat, organized environment creates a positive impression on the patient’s and family’s perception of care.

Optimized patient care is a win-win-win for user teams, patients, and administration.

- Create user defined space now and for decades of changes to come
- Attach and move clinical tools including monitors and computer equipment without damage to the walls
- Multiply and change locations of medical gasses
- Support LEAN initiatives and manage inventory control
- Clear floor space at the bedside with IV pole management
- Improve HCAHPS scores



**Paladin
Medical
Products**

(407) 614-8781 office
info@PaladinMP.com

CHALLENGE

Traditional mounting of equipment is a consistent drain on precious financial resources caused by changing contracts, new technology, and staff requirements.



REDUCE ROOM LIFECYCLE COSTS BY MORE THAN 75%



SOLUTION

The "Evolution" Equipment Management Rail System allows for unlimited changes without the need for patch and repair, lost patient stay revenue, or perfectly planned placement.

Simply unlock the adapter and items snap-on and snap-off at will.

The burden of change is on the adapter and mounting hardware, not the walls and the furnishings.

- Adapters and mounting plates embedded with active anti-microbial infection technology
- Devices, Equipment, and Accessories snap-on and snap-off
- Lockable snap-on adapter for tamper-proof placement of items
- Flexible, Adaptable, Expandable for limitless contractual changes and user definition of space



**Paladin
Medical
Products**

(407) 614-8781 office
info@PaladinMP.com

CHALLENGE

Digging for supplies with gloved hands breeds issues of cross-contamination, Hospital Acquired Infections, and wasted time.

Inventory systems are plagued by "First-In, Last-Out" syndrome. Unused materials become expired or cannot be restocked into Clean Supply.



LEAN INVENTORY AND INFECTION CONTROL



SOLUTION

LEAN supply inventory management at the bedside provides clinicians with
WHAT THEY NEED
WHEN THEY NEED IT
WHERE THEY NEED IT
IN QUANTITIES THEY NEED

Reducing waste from over purchasing or items that cannot be restocked into Clean Supply.

Implementing the "Evolution" Medical Equipment Management Rail and Accessories System reduces the risks of cross-contamination, the acquisition of HAI's, and the wasted expense of expired and unused materials.

- Clips, Hooks, Bins, and Baskets of varying sizes and multi-use purposes
- Clear bins for quick visual identification of stock for supplies
- Embedded anti-microbial agents in all plastic adapters and powder coat painted finish
- Snap-on, snap-off features for easy relocation and reorganization of supplies
- Lockable adapters for tamper-proof placement



**Paladin
Medical
Products**

(407) 614-8781 office
info@PaladinMP.com

CHALLENGE

Gas outlets are often in short supply and/or in the wrong location.

The traditional "Y" extension causes permanent damage to the wall outlet creating leaking gases and the need for repair and replacement. This solution creates an unnecessary burden on the Operation's Budget.



NON-INVASIVE GAS EXPANSION



SOLUTION

An evidence based solution that virtually eliminates the need for repair or rebuilding of wall outlets.

Safely multiply and relocate gases without shutting down services or damaging in-wall outlet infrastructure.

Mount gas blocks and flow meters to the "Evolution" Equipment Management Rail to place the load-bearing burden on the rail, not the coupling in the wall outlet.

- Splitters and adapters for any brand or model service outlet
- Flexible, Adaptable, Expandable for easy and safe expansion and repositioning of services
- Eliminate regular repair of wall outlets damaged from the use of "Y" splitters
- Splitter blocks lock securely onto the rail. Flow meters stay in place rather than "walking" from department to department.



**Paladin
Medical
Products**

(407) 614-8781 office
info@PaladinMP.com

CHALLENGE

Mounting equipment directly to the wall is a costly proposition when changes need to be made. The inevitable changes damage finishes and furnishings that often cannot be repaired—Corian, wall covering, laminate, veneer, etc.

EQUIPMENT MANAGEMENT



SOLUTION

The "Evolution" Medical Equipment Management Rail System provides for nearly unlimited reconfiguration of equipment and accessories to create and support a highly functional clinical environment for decades to come.

Easily make any necessary changes while the patient is in the room and without compromising their safety or comfort.

- Compatible with large scale equipment management tools from GCX, Human Scale, Ergotron, and many others
- Make changes without moving patients. No lost patient stay revenue.
- Complete new product changes in days instead of weeks or months.
- Proprietary embedded anti-microbial technology in our plastic adapters and powder coated items.





**Paladin
Medical
Products**

(407) 614-8781 office
info@PaladinMP.com

CHALLENGE

Traditional mounting of equipment often looks inconsistent and unplanned.



Installation mistakes render certain existing devices inoperable.



INCREASE HCAHPS SCORES SIMPLIFY FACILITY MAINTENANCE



SOLUTION

Perception = Reality

A neat and organized patient care setting presents the patient with a well managed environment. This has a direct positive impact on the perception of the care they receive.

Increased HCAHPS scores =
Increased reimbursements

Mounting to the "Evolution" Equipment Management Rail allows for unlimited changes without the need for patch and repair, lost room down-time, or perfectly planned placement.

- Adapters and mounting plates embedded with active anti-microbial infection technology
- Devices, Equipment, and Accessories snap-on and snap-off
- Lockable snap-on adapter for tamper-proof placement of items
- Flexible, Adaptable, Expandable for limitless contractual changes and user definition of space without facility burden



**Paladin
Medical
Products**

(407) 614-8781 office
info@PaladinMP.com

CHALLENGE

Per the CDC, many studies have shown that the bacteria that cause hospital-acquired infections are most frequently spread from one patient to another on the hands of healthcare workers.

In 34 studies of hand washing, workers washed their hands only 40% of the time.

The added cost of a typical HAI requiring additional time in the hospital is estimated to range from \$20,547 to \$25,903 for hospital stay costs, not accounting for the additional costs of litigation.

HANDWASHING, HAI's, AND REIMBURSEMENT



SOLUTION

Place all hand washing compliance and infection control accessories on the rail.

Studied and promoted by architect Harley Ellis Devereaux and published by the Center for Health Design in 2011:

Create a standard directional flow with easy access to sink and hand washing accessories at the room entry. "...placing the hand washing accessories on an equipment rail allows adjustment in the system without creating damage to the wall and potential home for pathogens."

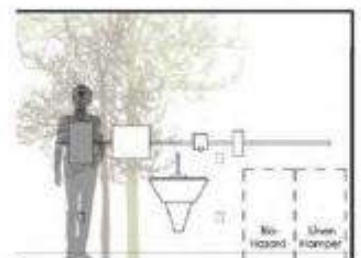
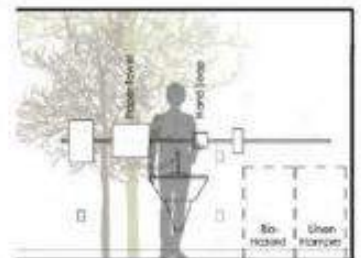
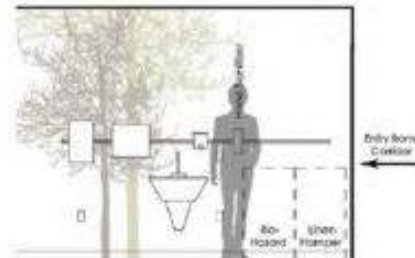



**Paladin
Medical
Products**

(407) 614-8781 office
www.PaladinMP.com

CHALLENGE

Traditional in-wall or "stick built" headwall systems offer no flexibility when the needs for additional services arise.

With lots of copper piping and electrical wiring, multiple brazing connections, and testing and certification, they can be very complicated and expensive to build.



HEADWALL SYSTEMS



SOLUTION

The Paladin "Revolution" Headwall systems are low-profile, are configured to the end-users requirements for gas outlet and electrical type and placement, and support hundreds of rail mounted accessories for total flexibility and adaptation. With a prefabricated manifold, single-point brazing connection with soft-feed for med gases, and an installation template, Revolution minimizes costs and simplifies installations.

Manufactured to change and expand as needs do, we offer the simplest system that is easily managed for decades to come.



















Prefabricated headwall system and manifold to save an average of 25% on installation labor, materials, and testing time

Supports hundreds of equipment management tools and accessories

Standard or custom configuration of gas and electrical outlets

Specify any manufacturer or type of outlet

Any RAL paint color with embedded anti-microbial finish or wide variety of wood grain

SANITIZING	PAPER TOWELS	PAPER TOWEL DISPENSER - GA PACIFIC SOFPULL #58470	GLOVES DISPENSERS	WASTE CONTAINERS
<p>HAND SANITIZER/ SOAP DISPENSER - MANUAL PUMP 5.5"W X 10"H X 3.5"D IC-110</p>  <p>PLAN VIEW</p>	<p>PAPER TOWEL DISPENSER - METAL TRIFOLD 11"W X 14"H X 4"D IC-401</p>  <p>PLAN VIEW</p>	<p>PAPER TOWEL DISPENSER - UNIVERSAL FOLD KIMBERLY CLARK 11"W X 14"H X 5"D IC-403 IC-406</p>  <p>PLAN VIEW</p>	<p>TRIPLE GLOVES BOX HOLDER - WIRE 10"W X 16"H X 4"D IC-208</p>  <p>PLAN VIEW</p>	<p>SHARPS CONTAINER - LARGE (KENDALL) 14.5"W X 16"H X 6.5"D IC-302</p>  <p>PLAN VIEW</p>
<p>HAND SANITIZER/ SOAP DISPENSER - AUTOMATED 5.5"W X 10"H X 3.5"D IC-110</p>  <p>PLAN VIEW</p>	<p>PAPER TOWEL DISPENSER - KIMBERLY CLARK SANITOUCH 2-HAND PULL-DOWN 12"W X 16"H X 10"D IC-404</p> 	<p>TRIPLE GLOVES BOX HOLDER - ABS HORIZ. TOP FEED 16"W X 10"H X 4"D IC-219</p>  <p>PLAN VIEW</p>	<p>TRIPLE GLOVES BOX HOLDER - ABS 10"W X 16"H X 4"D IC-211</p>  <p>PLAN VIEW</p>	<p>SHARPS CONTAINER - (KENDALL STD OR BD SHARPS) 13.5"W X 14.5"H IC-311</p> 
<p>HAND FOAM, 9 OZ. 2.5"W X 8.5"H IC-103</p> 	<p>PAPER TOWEL DISPENSER - EN-MOTION 14"W X 17"H X 9.5"D IC-405</p> 	<p>DOUBLE GLOVES BOX HOLDER - METAL VERT. TOP FEED IC-202</p>  <p>PLAN VIEW</p>	<p>DOUBLE GLOVES BOX HOLDER - METAL VERT. TOP FEED IC-202</p>  <p>PLAN VIEW</p>	<p>RUBBERMAID WASTE BIN - 3 GALLON 11.375"W x 8.25"D x 12.125"H IC-XXX</p> 
<p>WIPES - ADJUSTABLE HOLDER 5" +/- DIA X 4"H IC-112</p>  <p>PLAN VIEW</p>	<p>PAPER TOWEL DISPENSER - GA PACIFIC EN-MOTION 13.25"W X 13.25"H X 9.5"D IC-40X</p> 	<p>RAIL MOUNT KIT ONLY FOR 3 SINGLE GLOVES BOX HOLDERS WITH COVERS #BD-305448 21.5"H X 12"W X 4.5"D IC-243</p> 	<p>ACCESSORIES KEY / LEGEND</p>	<p>SCALE: 1/2" = 1'-0" DATE: 02-12-14 REV 1: REV 2: REV 3: REV 4:</p>

KEY.1















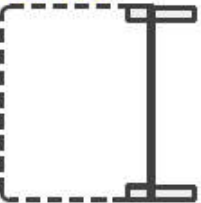



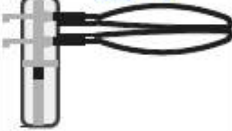
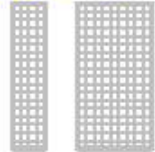

SHEET NO.

Paladin Medical Products
Architectural Solutions for Clinical Environments
The Fairfield Legacy Company

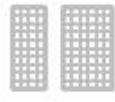
840 W. Ceiland Avenue, Suite A1
Oakland, FL 34787
(321) 704-3211 ph
gachindale@paladinmmp.com

















PACKAGE:

© 2013 BY PALADIN MEDICAL PRODUCTS. ALL RIGHTS RESERVED. THIS DOCUMENT IS THE PROPERTY OF PALADIN MEDICAL PRODUCTS. IT IS TO BE USED ONLY FOR THE SPECIFIC PROJECT IDENTIFIED OR REFERRED TO HEREIN AND IS NOT TO BE USED ON OTHER PROJECTS OR EXTENSIONS TO THIS PROJECT, IN WHOLE OR PART, EXCEPT BY EXPRESS WRITTEN AGREEMENT WITH AND COMPENSATION TO PALADIN MEDICAL PRODUCTS.

WELCH ALLEN	BASKETS	BINS	HOOKS AND CLIPS	WORK SURFACES
 SPECULA DISPENSER 5"W X 9"H X 2"D DEM-109 PLAN VIEW	 DEEP WIRE BASKET - MEDIUM 16W x 10H x 15D SM-104	 3 BIN SUPPLIES HOLDER 23 5/8"W X 9.5"H X 4.25"D SM-201	 WIRE CHART HOLDER 13"W X 10"H SM-106	 FOLD DOWN SHELF 24"W X 18"D SM-220
 PLAN VIEW OPHTHALMOSCOPE MODEL #777 8"W X 6.5"H X 3"D DEM-108	 DEEP WIRE BASKET - LARGE 24W x 10H x 16D SM-105	 4 BIN SUPPLIES HOLDER 23 5/8"W X 6.5"H X 4.25"D SM-202	 6-CLIP ORGANIZER 22"W X 2"H SM-401	 FOLD DOWN SHELF 18"W X 12"D SM-221
 PLAN VIEW OPHTHALMOSCOPE MODEL #767 16"W X 6.5"H X 3"D DEM-108	 WIRE BASKET - LARGE 18"W X 4"H X 9"D SM-103 PLAN VIEW	 5 BIN SUPPLIES HOLDER 23 5/8"W X 6.5"H X 4.25"D SM-203	 3-CLIP HANGER 12"W X 2"H SM-403	 FOLD DOWN SHELF 15"W X 10"D S-216 PLAN VIEW
 THERMOMETER 7"W X 9"H X 2"D DEM-110 PLAN VIEW	 WIRE BASKET - SMALL 10"W X 4"H X 6"D SM-102 PLAN VIEW		 3-HOOK HANGER 12"W X 2"H X 4-1/2" LONG HOOKS SM-302	 FLAT SHELF 14"W X 2.25"H X 13"D S-203 PLAN VIEW
 BLOOD PRESSURE MANOMETER 7"W X 7"H X 1.5"D DEM-105 PLAN VIEW	 U-SHAPED WIRE BASKET 6 1/2"W X 7"H X 4"D SM-101		 1-HOOK HANGER 2.25"W X 2"H X 4-1/2" LONG HOOK SM-301	 FLAT SHELF 10"W X 2.25"H X 8"D S-201 PLAN VIEW

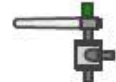
 Paladin Medical Products Architectural Solutions for Clinical Environments The Fairfield Legacy Company 940 W. Oakland Avenue, Suite A1 Oakland, FL 34787 (321) 704-3211 ph gschindele@paladinmp.com	ACCESSORIES KEY / LEGEND EQUIPMENT MANAGEMENT	SCALE: 1/2"=1'-0" DATE: 02-12-14 REV 1: REV 2: REV 3: REV 4:	<h1>KEY.2</h1> SHEET NO.
--	--	---	-----------------------------

COPYRIGHT © 2013 BY PALADIN MEDICAL PRODUCTS. ALL RIGHTS RESERVED. THIS DOCUMENT IS THE PROPERTY OF PALADIN MEDICAL PRODUCTS. IT IS TO BE USED ONLY FOR THE SPECIFIC PROJECT IDENTIFIED OR REFERRED TO HEREIN AND IS NOT TO BE USED ON OTHER PROJECTS OR EXTENSIONS TO THIS PROJECT, IN WHOLE OR PART, EXCEPT BY EXPRESS WRITTEN AGREEMENT WITH AND COMPENSATION TO PALADIN MEDICAL PRODUCTS.

INFUSION PUMP MANAGEMENT	COMPUTER EQUIPMENT	MED GAS	GENERAL ACCESSORIES	VACUUM BOTTLE SLIDE 2"W X 4"H AC-101
 IV POST 1" DIA X 4"H IM-101 SCALE: 1"=1'-0"	GCX CHANNEL  4"W X 25"H GCX-101 4"W X 31"H GCX-102	GAS SPLITTER BLOCK - WALL  GBO-XXX GBA-XXX GBV-XXX SCALE: 1"=1'-0"	VACUUM BOTTLE WITH SLIDE  5"W X 7"H SCALE: 1/2"=1'-0"	 SCALE: 1"=1'-0"
19.7"W X 5.5"H X 1.5"D WITHOUT POLE  SWING ARM HOLDER WITH IV POLE IM-303 *DOES NOT INCLUDE GCX MOUNT*	CAPSULE NEURON ON DOCKING STATION 	GAS SPLITTER BLOCK ON RAIL  SBO-XXX SBA-XXX SBV-XXX SCALE: 1/2"=1'-0"	EMISIS BAG HOLDER  8"W X 8"H IC-312 SCALE: 1/2"=1'-0"	
MONITOR  KEYBOARD 	BAR CODE SCANNER  4"W X 5"H SM-101 SCALE: 1"=1'-0"	OXYGEN FLOW METER ON GAS BLOCK  3"W X 6"H FMO-XXX SCALE: 1"=1'-0"	DOCUMENT CLIP  9"W X 1.5"H SM-406 SCALE: 1/2"=1'-0"	
RETROFIT TO EXISTING CONDITIONS: AVAILABLE AS POLE-MOUNT	AIR FLOW METER ON GAS BLOCK  3"W X 6"H FMA-XXX SCALE: 1"=1'-0"	XX-XXX SCALE: 1"=1'-0"		
SCALE: 1"=1'-0"	VENTILATOR MANIFOLD  GBVM-001 SCALE: 1"=1'-0"			

 Paladin Medical Products Architectural Solutions for Clinical Environments — The Fairfield Legacy Company —	ACCESSORIES KEY / LEGEND EQUIPMENT	SCALE: 1/2"=1'-0" DATE: 02-12-14 REV 1:	REV 2: REV 3: REV 4:	<h1>KEY:3</h1> <p>SHEET NO.</p>
--	---	--	---	---------------------------------

COPYRIGHT © 2013 BY PALADIN MEDICAL PRODUCTS. ALL RIGHTS RESERVED. THIS DOCUMENT IS THE PROPERTY OF PALADIN MEDICAL PRODUCTS. IT IS TO BE USED ONLY FOR THE SPECIFIC PROJECT IDENTIFIED OR REFERRED TO HEREIN AND IS NOT TO BE USED ON OTHER PROJECTS OR EXTENSIONS TO THIS PROJECT, IN WHOLE OR PART, EXCEPT BY EXPRESS WRITTEN AGREEMENT WITH AND COMPENSATION TO PALADIN MEDICAL PRODUCTS.